



# S.KI Tipper Semi-Trailer

Greater payload for construction, agriculture and recycling

## Contents

### Schmitz Cargobull Service Portfolio

- 2 One-Stop Solution

### SMART PLUS Package

- 4 Your One-Stop Complete Solution with SMART PLUS Package  
5 The SMART PLUS Package at a Glance

### Construction Vehicles

- 6 S.KI SOLID Tipper Semi-Trailer with a Rounded Steel Body  
7 Cost-Effective Rounded Steel Body  
8 S.KI LIGHT Tipper Semi-Trailer with Aluminium Box Body  
9 Rear Wall Range  
10 Hydraulic Tailgate  
11 Body Coverings

### Thermal Insulation

- 12 Rounded Steel Body with Thermal Insulation  
13 Fully Insulated Aluminium Box Body

### S.KI Control App

- 14 Simple Handling trough Remote Control  
15 Innovations at a Glance

### High-Volume Bodies

- 16 S.KI VOLUME with Aluminium Box Body  
17 Roller Tarpaulin with Bow-shaped Tarpaulin Frame  
18 S.KI VOLUME Tipper Semi-Trailer with Rounded Steel Body  
19 Rear Walls

### Chassis and Running Gear

- 20 Solid Steel Chassis  
21 ROTOS DriveTechnology

### Equipment and Accessories

- 22 Equipment and Accessories  
23 **Contact**

## One-Stop Solution

At Schmitz Cargobull you get a comprehensive range of services to meet all your trailer-related needs over its entire service life. From the financing of your vehicle and on-the-road service to value retention by means of fair trade-in offers. Reduced downtime increases the availability of your trailers and guarantee their retained value. And all at low and agreed costs – throughout the service life of your trailer.



Tailored financing solutions and insurances from the industry expert



Second-hand – first-class certified-quality used trailers

Procurement

Valuation and sales

## Usage

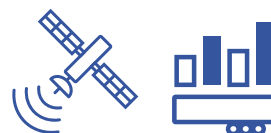

TrailerConnect® telematics for smart logistics and fleet management

24h



Original spare parts available in 24h, order online with the EPOS portal



Full Service for the trailer, refrigeration unit and tyres

24h



24h Cargobull Euroservice Europe-wide breakdown service



1,700 Service Partners – your specialist workshop for Full Service

## Our Service Portfolio – Your Benefits:



- One-stop shopping: one central contact for all trailer-related issues
- 100 % Schmitz Cargobull for the entire service life of your trailer
- Service solutions from industry experts, perfectly coordinated to the Schmitz Cargobull product range
- Europe-wide service and fleet management via online portals
- Financing, Full Service, trailer telematics, second-hand trailers – individual service packages for every use
- Cost and price transparency with genuine spare parts and the highest service quality
- Reliable transport industry system partner for comprehensive transport solutions

Please refer to the Service brochure for further information.



## Your One-Stop Complete Solution with SMART PLUS Package

Standard equipment in conjunction with Schmitz Cargobull's comprehensive services make the S.KI 24 SL SMART tipper semi-trailer with SMART PLUS package the perfect transport solution to meet your needs. You can combine all vehicles from the Schmitz Cargobull tipper range, delivered with an Extra-LIGHT chassis, with the SMART PLUS package. Customised financing from our industry experts is also available on request.



### The S.KI SMART tipper semi-trailer

Our TrailerConnect® telematics system integrated in the S.KI tipper semi-trailer, as well as the CTU3 acting as central control unit, are perfect for the smart networking of all trailer data from the EBS, optional sensors (including tyre pressure control) and ultra-durable hardware. The system is displayed and partially controlled by the user-friendly TrailerConnect® telematics portal 2.0. Use trailer telematics to optimise your dispatch, retain an overview in fleet management and optimise your maintenance. Reduce your costs, at the same time as improving the availability of your trailers.



\* Optional.

## The SMART PLUS Package at a Glance

The following features transform your S.KI SMART tipper semi-trailer into an uncompromisingly cost-effective transport solution:

- Extra-LIGHT chassis
- Trailer telematics system
- Tyre pressure monitoring
- Brake pad wear indicator+\*\*
- LED tail lights plus four reversing lights at the rear and at both sides above the running gear.



### Full Service trailer:

Covers maintenance and service costs, replacement of all wear parts on the trailer

(hydraulics and body\*) at over 1,700 Service Partners, Europe-wide breakdown service with payment guarantee and handling by Schmitz Cargobull. The contract applies without a mileage (km) limit.



### Trailer Telematics:

Rapid access to the TrailerConnect® telematics service including a digital map

(Google Maps) thanks to pre-installed hardware. The integrated WLAN allows the access to all of the telematics data at any time via the beSmart App.



**Full Service tyres:** New tyres from premium brands to match your specific needs, optionally for use on roads or construction sites. More

than 2,500 Service Partners in Europe. Europe-wide breakdown service with payment guarantee and handling by Schmitz Cargobull. The replacement costs for wear, tyre failures and impact damage are covered completely.



**Financing:** Fair monthly rates including all service components that take into account the improved value retention

of the vehicle. Tailored contracts with customised terms and winter payment break\* upon request.

## Your Benefits:

- **Robust, weight-optimised Extra-LIGHT chassis**
- **TrailerConnect® telematics hardware and TrailerConnect® Info telematics service**
- **Tyre pressure control system – higher safety and reliability**
- **Brake pad wear indicator+ for a tyre-specific brake pad condition indication – less wear and damage, reduction in costs**
- **LED lighting system – long service life with minimum energy consumption**
- **Full Service trailer and tyres**
- **Greater value retention and reduced Total Cost of Ownership (TCO)**
- **Competitive financing\*, as all benefits are included in a single monthly instalment. Financing with winter payment break\***
- **Higher residual value**



Two reversing lights at the sides and rear are low-maintenance parts, combining a large light output with low energy consumption.

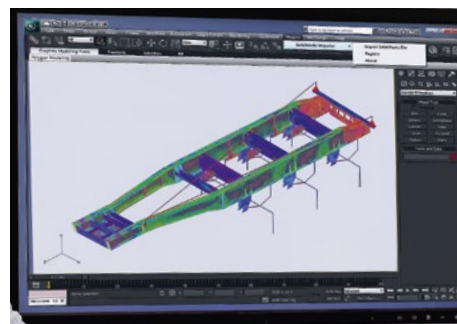

Extra-LIGHT chassis: FEM-designed for maximum torsional stiffness while optimising the payload.



Tyre pressure control system reduces tyre wear, fuel costs and frequency of breakdowns.

\* Optional.

\*\* Tyre-specific worn brake pad indication.

## S.KI SOLID Tipper Semi-Trailer with a Rounded Steel Body

Our S.KI tipper semi-trailers with a rounded steel body are the cost-effective transport solution for construction site traffic. They stand out on account of their low procurement and repair costs coupled with excellent wear resistance. Furthermore, they are ideal for the transport of abrasive materials, like sand, gravel, additives and asphalt, with appropriate models also being suitable for use with lumps of rock and concrete. They are ideal for short journeys and frequent tipping operations.

### Your Service Benefits:



**Full Service contract including body and tyres**



**Financing with winter payment break**



**Express delivery after 7 working days\*\***

**S.KI SOLID with an empty weight from 5.5 t\***

Construction bodies with volumes from 21 to 36 m<sup>3</sup>



Folding underride guard for work with a road paver

LED multi-chamber light with dynamic indicator\*\*\*

LIGHT, Standard or Heavy Duty steel chassis variants depending on the application

## Your Benefits:

- Low centre of gravity due to flat, broader base to reduce the loading height, making the vehicle more stable and safer
- The shape of the body prevents the cargo from adhering to the surface, increasing safety when unloading
- The FEM optimises both the weight and the payload of the welded lightweight steel chassis. It is more durable, easier to repair and has a longer service life than an aluminium body

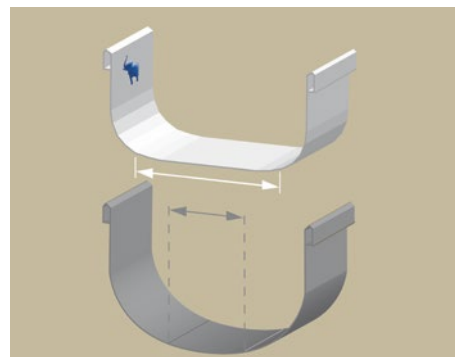

Rounded steel body with an optimised cross-section for improved vehicle handling.



The flat base of the rounded steel body provides a lower loading edge, whilst retaining the same volume.



The low centre of gravity of the body optimises tipping stability. The tilt angle assistant issues a warning in the event of excessive sideways tilting.\*



The automatic lowering function provides greater stability when tipping and can be deactivated if necessary.

The two-axle tipper semi-trailer provides benefits on tricky terrain. The tipper semi-trailer's load distribution is designed to be combined with three-axle semi-trailer tractors and provides the tractor unit with adequate fifth-wheel loading.



## Cost-Effective Rounded Steel Body

Create the optimum body for your construction site work and combine different lengths and heights with different material thicknesses. Volumes of between 21 and 36 m<sup>3</sup> are possible. The result is a perfect solution of volume, weight and use. Stability and durability are guaranteed due to the stress-resistant design with varying wall thicknesses and by the use of high-strength fine-grain steel, as guaranteed by our own material inspection.

\* Optional.

# S.KI LIGHT Tipper Semi-Trailer with Aluminium Box Body

The aluminium box body is the payload-optimised means of transport with an outstanding overall operating cost balance for long distances with slightly abrasive bulk materials, like sand, gravel and stone chips, and with chemically aggressive bulks materials, like gritting salt. The lightweight alternative is not at the cost of body stability. The body, made of 40 mm thick system profiles, a wall thickness of 2.5 (S.KI LIGHT) or 3.5 mm and optional wear plates make sure of this.

## Your Benefits:

- **Ultra-economical:** robust, welded steel chassis and offroad-capable running gear
- **The design of the body reduces weight in favour of a higher payload**

**S.KI LIGHT with an empty weight from 4.8 t\***

Lightweight box body made of Schmitz Cargobull aluminium system profiles



The interior has a plastic coating\*\*



Wear plates on the interior side walls\*\*



Additional handle on the pendulum tailgate\*\*



## Your Service Benefits:



**Full Service contract including body and tyres**



**Financing with winter payment break**

\* Depending on configuration and equipment. \*\* Optional.





Supported tailgate with surrounding gasket and additional clamping locks.



Internal pendulum tailgate with chute.



The combi-door enables the bulk goods to be tipped by means of a pendulum function, grain slider or door function.

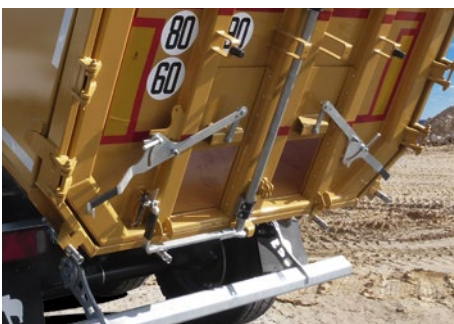

Finely metered unloading through two sliders in a combi-door.

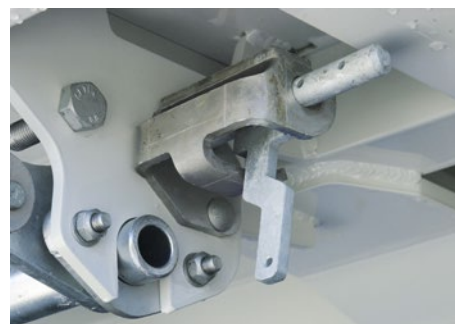

Pegs block the hook lock when using the grain slider to unload the trailer.

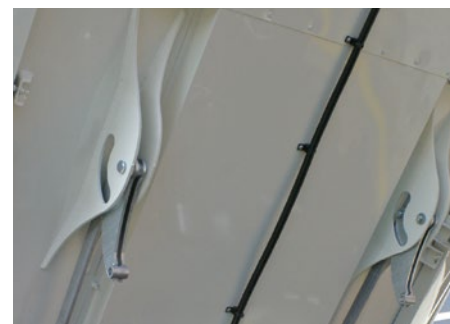

Automatic-mechanical hook lock with two pull rods.

## Rear Wall Range

You have the choice of several rear wall solutions. The external pendulum tailgate is sensible for the frequent partial unloading of bulk materials. The internal pendulum tailgate with chute is recommended for guided unloading with a road paver. We would be happy to equip your rear wall with a slider – the pendulum tailgate with one and the combi-door with up to two sliders. External tailgates and combi-doors are equipped with a double pendulum bearing to provide the best possible opening cross-section and prevent damage to the tailgate.

## Hydraulic Tailgate

The hydraulic tailgate is ideal for frequent tipping and for heavy granulated materials. Three functions can be selected via a switch on the I-beam or using an app. The hydraulically operated tailgate starts up once the tipping process has started. It can open fully, for instance, to provide the maximum opening cross-section. Simply select unloading through the slider if you wish to unload your freight in controlled volumes. The pendulum function completes the range of functions.



The opening angle is infinitely adjustable. When transporting high-volume bulk materials, the maximum opening cross-section ensures damage-free unloading.



The mechanics are located outside the tipping area. Cylinders and lines are mounted in protected positions on the body.



Thanks to the integrated pendulum function, the tailgate opens according to the tilt of the body.



Controlled unloading with a hydraulic tailgate through the slider.

## Gotha Plant



During the course of the development, the vehicles are tested on Schmitz Cargobull's own in-house tipping test rig to determine the tipping stability and torsion resistance.



Up to 7,500 tipper semi-trailers a year are manufactured on our production line to a precise schedule.



Partially automated production systems for rounded steel and aluminium box bodies always guarantee a consistently high quality.



Side roller tarpaulin closed: covering the load also saves fuel as it improves the aerodynamics of the S.KI tipper semi-trailer. Load securing thereby increases profitability.



Working platform with slip resistant floor, trough boarding aid and parking position for the hydraulic hose.



Time-saving: manual roller tarpaulin with quick-tensioning device.

## Body Coverings

Whether manually operated roller tarpaulins or electric sliding tarpaulin – both protect the freight and guarantee safety out on the road. The advantages of electric sliding tarpaulins are clear for all to see: no handling on the working platform – rather simple, fast operation from the ground. With roller tarpaulins, the arched transverse bows prevent water from collecting on the tarpaulin and enable the roof to be closed, even over protruding loads.



The Schmitz Cargobull sliding tarpaulin is supplied either as a manual or electric model. The side mountings with roller hooks and a Z-profile improve the handling.



The bevel gear and the drive for the sliding roof are protected beneath the protective canopy of the front wall.



The control panel for the electric sliding tarpaulin is fitted to the longitudinal beam.

## Rounded Steel Body with Thermal Insulation

Smooth and made-to-measure on all sides: our thermal insulation for your rounded steel body provides the perfect transport solution for the more exacting demands of motorway construction. The insulated pendulum tailgate provides insulation, as does the temperature-resistant roller tarpaulin.

**Greater payload:  
empty weight  
from 5.8t\***

**Thermal insulation  
in compliance  
with  
DIN 70001**



All thermally insulated bodies feature side openings for four-point temperature measurement.



### Your Benefits:

- Ultra-lightweight, flexible, highly efficient organically-based insulating foam
- Unladen weight of insulating elements from 310 kg
- Unladen weight from 5,790 kg
- Low centre of gravity of the semi-trailer
- Floating, easily replaceable insulation segments
- High-quality, temperature-resistant roller tarpaulin, also available as a sliding tarpaulin
- On request: prepared for the fitting of electronic measuring technology



Future-proof: access points for manual direct temperature measurement and mounting for the installation of digital measurement equipment\*\*.



The rounded steel body with efficient underbody insulation lies precisely on the rubber chassis support.



Repair-friendly external insulation – individual segments can be quickly replaced in the event of damage.



External thermally insulated pendulum tailgate is suitable for partial unloading. Optionally with slider.

\* Depending on configuration and equipment. \*\* Optional.

## Your Benefits:

- Payload-optimised full thermal insulation for construction site vehicles from 5,170 kg
- Low unladen weight of insulating elements from 380 kg
- Low centre of gravity – the body has the same dimensions as the conventional versions
- High-quality, temperature-resistant tarpaulins with convenient quick-acting locking device or electric sliding tarpaulin
- On request: preparation for electronic measuring equipment



Thermal insulated rear wall, optionally with external pendulum tailgate or internal pendulum tailgate with chute.

## Fully Insulated Aluminium Box Body

The use of a fully insulated aluminium box body with a LIGHT chassis is the weight-optimised transport solution for road construction. A high payload is possible in conjunction with lightweight insulation components. The insulation is set flush with the floor, only marginally decreasing the body volume on the side walls.

The body is available with an external tailgate or an internal pendulum tailgate with chute. On request, the aluminium box bodies are prepared for retrofitting with measurement sensors.



The folding underride guard provides greater clearance when tipping the asphalt into the road paver.



Wear plates optimise the durability of the rear part of the aluminium box body\*\*.

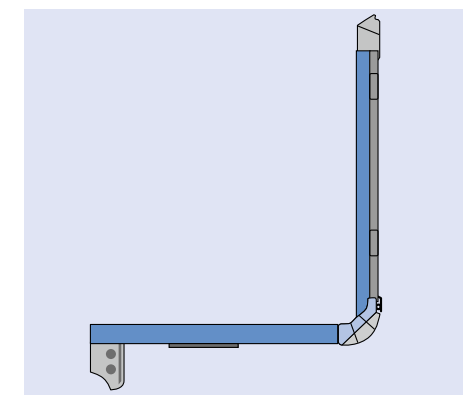

Insulation of the floor and side walls of the aluminium box body using high-temperature rigid foam.

\* Depending on configuration and equipment. \*\* Optional.

## Simple Handling through Remote Control

Key functions on the S.KI tipper semi-trailer can be controlled and monitored with the S.KI Control app. The app is available for smartphones and tablets with an Android or iOS operating system.

### Your Benefits:

- Greater safety and efficiency when loading by the control of various functions from the cab
- Increased active and passive safety when tipping
- Avoidance of overloading
- Monitoring of the freight and area behind the semi-trailer
- Less tyre wear and avoidance of breakdowns caused by tyre damage
- Lower fuel costs, thanks to optimum tyre pressure



# Innovations at a Glance



**Weighing system** reliably indicates the weight of the bulk material in the body, thereby avoiding overloading.



**Automatic lowering** of the pneumatic suspension in the running gear when unloading provides a better trailer position due to a lower centre of gravity.



**Automatic starting aid** increases traction through automatic raising of the lift axle if the truck drive axle loses grip when driving off.



**Automatic axle load compensation** optimises the load distribution and makes sure that the axle loads are balanced when the body is not evenly loaded.



**Adjustable paver brake** permits adjustment of the brake pressure when working with the road paver and is controlled via the smartphone app.



**Electronic pneumatic suspension** ensures suspension comfort, regardless of the load, for optimum road holding and permits differentiated settings to be made to the running gear.



**Tipping angle assistant** measures the exact tipping angle via a sensor at the tipping bearing and automatically brakes if the body tilts when driving.



**Articulation angle assistant** measures the position of the tractor unit relative to the trailer during loading and unloading. Ideally they should be perfectly aligned.



**Tilt angle assistant** measures the lateral tilt of the vehicle on uneven surfaces before the tipping process begins. If the lateral tilt is too large the tipping process is stopped.



**Cargo area camera\*** uses a Wi-Fi connection to show a current video image in the smartphone app to monitor loading processes.



**Rear area camera** features a WiFi connection to show the manoeuvring area behind the trailer in the smartphone app. This makes manoeuvring and tipping easier.



**Rear wall remote control:** Three different operating modes can be pre-set and activated during the tipping process.



**Tyre pressure control with re-inflation function** automatically re-establishes the pre-set air pressure in the individual tyres of the running gear and emits a warning in the event of a loss of air to avoid the need to stop.



**Remote control of the electric tarpaulin\*** permits fast load securing via a smartphone app in approx. 25 seconds. Climbing onto the working platform and manual handling of the tarpaulin are no longer necessary.



**Pneumatic underride guard** can be moved upwards and downwards by a button on your smartphone. The position of the underride guard is also displayed.



**Remote control by a smartphone app** enables the above mentioned functions to be controlled independently of the tractor unit. Permanently installed switches in the driver's cab are superfluous. For remote control a standard WiFi-capable mobile device (smartphone or tablet) can be used.



Two cameras monitor the flow of bulk materials and the rear area when tipping and manoeuvring with the road paver.



The tyre pressure control and re-inflation system actively monitors the tyre pressure in every single tyre.



Find out more at:  
[www.trailer-control.com](http://www.trailer-control.com)

\* Optional.

## S.KI VOLUME with Aluminium Box Body

The S.KI VOLUME AK tipper semi-trailer with its large aluminium body provides up to 60 m<sup>3</sup> of loading capacity to ensure that your harvest arrives clean, safely and gently at its intended destination. The large aluminium body is available with a straight or optionally with an offset chassis frame.

### Your Service Benefits:



**Fleet control with Trailer-Connect® telematics**



**Full Service contract including body and tyres**



Bulkhead-mounted working platform\* with individual adjustment of the platform height to ensure good stability.

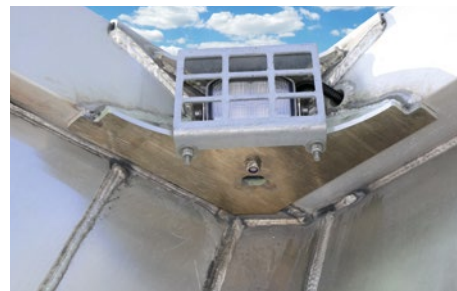

Interior lighting of the body allows it to be cleaned, even with the tarpaulin closed.

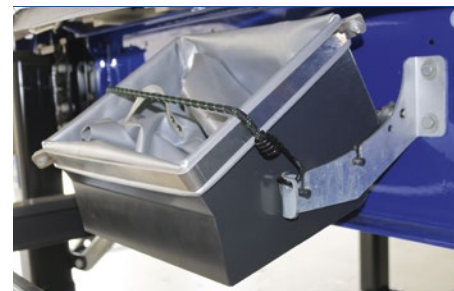

Grain hopper in parking position on the chassis.



Offset chassis for a lower loading height and a lower centre of gravity for improved ride stability.

\* Optional.





External pendulum tailgate with rubber seals on all sides, grain slider, four-hook locking and side clamping locks.



Combi-door: controlled unloading through the grain slider, tipping by the pendulum tailgate, loading through open doors.



Aluminium double wing door without pendulum frame and two grain sliders.

## Roller Tarpaulin with Bow-shaped Tarpaulin Frame

Easy operation: the improved roller tarpaulin can be comfortably and quickly closed from the ground using the long middle tensioning belt. It is not necessary to climb up on to the working platform to close the tarpaulin. In addition, the tensioning ratchets, with a broader handle and a larger lever, ensure a more comfortable handling. The tarpaulin flap fixed at the right makes it possible to unload with the tarpaulin closed, keeping the freight protected and losing no time to roll back the entire tarpaulin.



Combi-door with closed pendulum frame and wing door.



Tipping thanks to the fixed side doors.



The central tube in the roller tarpaulin makes the covering more stable.



The body can be emptied using the pendulum function when the roller tarpaulin is closed.

## S.KI VOLUME Tipper Semi-Trailer with Rounded Steel Body

Scrap metal and other heavy bulky goods present major challenges to transport vehicles. Our S.KI VOLUME SR tipper semi-trailer has evolved to handle this kind of bulk freight and stands out on account of its good profitability. The body, made of high-strength, dent-resistant fine-grained steel, is available in three lengths and two heights. Volumes of between 44 (S.KI SR 9.6) and 56 m<sup>3</sup> (S.KI SR 10.5) are available.

### Your Benefits:

- High operating times due to wear-resistant steel
- For maximum payload: S.KI with LIGHT chassis with a total weight of less than 8 t
- Robust, simple mechanical components securely lock the rear wall elements
- Paintwork of your choice in your company's colours
- The rounded steel body made of wear-resistant fine-grain steel represents durability, low maintenance and high value retention

**S.KI  
VOLUME SR:  
total weight of  
less than 8 t**



### Your Service Benefits:



**Full Service contract  
including body and tyres**



S.KI SR 8.2 with a high side wall for versatile uses – from construction site to bulk transport.

## Rear Walls

From solid wing doors to the well thought-out combi-door, our S.KI VOLUME tipper semi-trailer with a rounded steel body offers the appropriate rear wall model to meet your needs.



Door locking with pull function.



Symmetrically divided steel combi-door with pendulum function and grain sliders.\*



Double wing door open and bow for the roller tarpaulin.



The double wing door with short chute makes the body very accessible.



Locked: the hooks on the safety locks lock the doors of the tipper body.

\* Optional.

## Solid Steel Chassis

Reliable, load-bearing, maintenance-friendly, offroad-capable and good value retention: our steel chassis is designed to be torsionally rigid and guarantees a high level of tipping stability. From LIGHT to Standard to Heavy Duty\*, from weight-optimised light-weight design to high frame profile cross sections and wall thicknesses for additional reserves of strength – every chassis design meets your need for the greatest possible payload coupled with a low empty weight.



The welded steel chassis, made of high-strength fine-grain steel, used for the LIGHT design with weight-optimised frame assemblies, is the result of systematic weight reduction coupled with maximum safety, torsional strength and optimum payload. Comprehensive testing on the test rig at the Schmitz Cargobull Validation Center (CVC) verify the design data, at the same time ensuring the ongoing evolution of the chassis and all other trailer components.



The ALPHA hydraulic cylinder range provides a weight reduction of up to 28 kg for high-pressure systems and a high working pressure of max. 190 bar for low-pressure systems. With a body length of 7.2 m, the cylinder can be used for both high-pressure and low-pressure operation.



Hot galvanisation provides you with the best possible corrosion protection.



The finite element method (FEM) is a quality standard applied during CAD chassis construction.

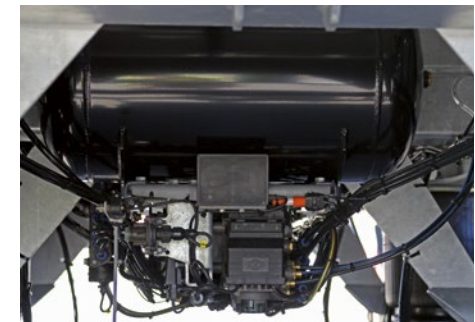

Aluminium air reservoirs are available for weight-optimised equipment.\*\*

## Your Benefits:

- Less heat generation results in greater brake performance
- Maintenance-free wheel bearings save costs
- Lower weight of the unsprung mass gives better vehicle handling
- Flexibility in terms of adjustment to trailer heights and loading ramps
- Safety thanks to standard EBS\* and RSP\* assistance systems
- Long maintenance intervals, thanks to large, low-maintenance disc brakes and maintenance-free hub units
- A load-dependent restraint system and steering damper ensure that the vehicle runs smoothly and quietly
- The electric starting aid is a standard feature and improves traction when starting offroad or on hills
- Lift axle: lifting the first axle reduces the amount of tyre wear during empty runs. Optional for the second axle

**ROTOS**



Running gear  
Warranty  
**500,000 km**  
or 3 years\*\*

ROTOS running gear is equipped with MRH (Multi Ride Height) pneumatic suspension as a standard feature

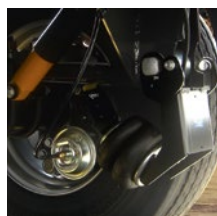

Standard: lift axle.

22.5" axle hub: 430 mm diameter brake disc for maximum performance

Innovative ventilation system: air in the axle hub is drawn in from the outside past the hub and directed both onto and into the brake disc, thus cooling the brakes and wheel bearings. The benefit for you: the brake performance remains reliable, even during constant operation, and the brake pads last longer.

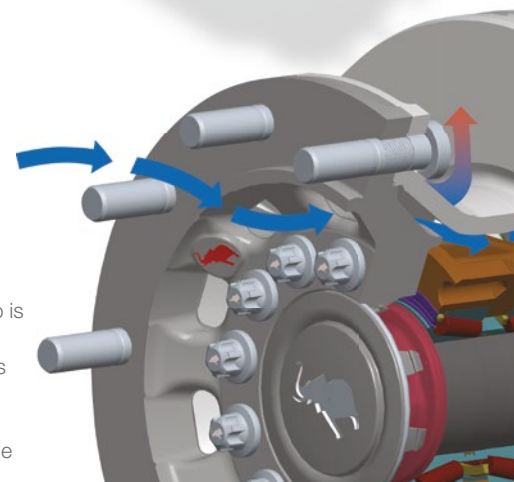

## ROTOS DriveTechnology

Our ROTOS running gears provide outstanding road handling combined with uncompromising availability. The extremely low-vibration axle solely consists of well-known brand-name manufacturers' components.

the ROTOS running gear is available with two different brake disc sizes for the tipper semi-trailer. The ROTOS running gear with self-steering axle is also available on request.



Please refer to the ROTOS brochure for further information.



See the video at YouTube. ROTOS. The running gear.

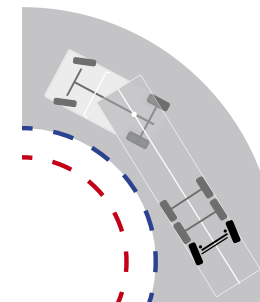

ROTOS running gear with self-steering axle, when used as the 3rd axle, increases the manoeuvrability of the tractor at full payload.

\* EBS – electronic brake system; RSP – Roll Stability Program.

\*\* Excluding wear parts. Warranty meets the requirements for off-road use and tipper vehicles.

## Equipment and Accessories

Various equipment options offer you all kinds of options confidently overcoming the challenges of everyday work with your S.KI tipper semi-trailer.



Mechanical landing gear with compensating feet.



The steel drop supports are secured with locking pins – a weight-saving solution.



Lightweight detachable stabilisers are the right solution for permanent tractor-trailer units, the trailers of which are rarely disconnected.

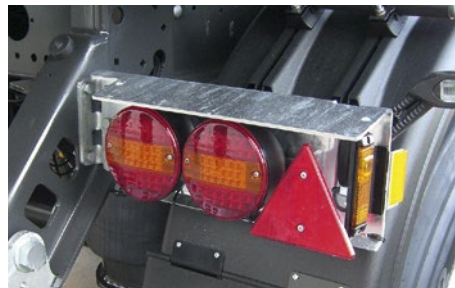

Round three-chamber LED rear lights for ease of repair in the event of damage.



Long-life rear LED lights provide highly visible warning signals.

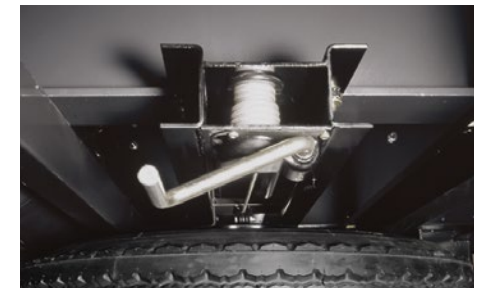

Spare wheel carrier, loop version.



Compressed air roller vibrator for even fast-flowing bulk materials and shorter unloading times.



Offroad tyres for the best vehicle handling.



The fire extinguisher on the chassis is quickly accessible in the event of an emergency.



Spare wheel basket under the chassis, in front of the axle unit.



Additional reversing lights with LED technology.\*



The brush and shovel are easily accessible and rapidly stowed.

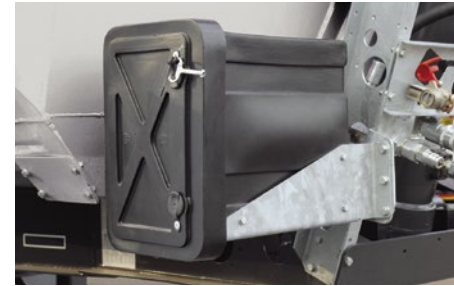

Sturdy tool box on the chassis.



Lightweight aluminium rims for weight reduction and a high-quality appearance.



The odometer mounted on the wheel hub provides information about the tipper semi-trailer's mileage (km).



The folding underride guard enables easy feed of road pavers. Optionally with pneumatic operation (top). The underride guard, optimised for use with road pavers, provides improved ground clearance when retracted (centre).



Water tank for 30 litres on the I-beam.



Overloading protection: the loading pressure gauge shows the air bellows pressure.

\* Optional.

## Schmitz Cargobull Sales Germany:

### Schmitz Cargobull AG

Bahnhofstraße 22  
D-48612 Horstmar, Germany  
Phone: +49 (2558) / 81-7001  
Fax: +49 (2558) / 81-91279  
E-mail: [vertrieb.deutschland@cargobull.com](mailto:vertrieb.deutschland@cargobull.com)  
Web: [www.cargobull.de](http://www.cargobull.de)

## Schmitz Cargobull Sales Austria:

### Schmitz Cargobull Austria GmbH

Bayernstraße 54  
A-5071 Wals-Siezenheim, Austria  
Phone: +43 (662) 881587-0  
Fax: +43 (662) 88158715  
E-mail: [vertrieb@cargobull.at](mailto:vertrieb@cargobull.at)  
Web: [www.cargobull.at](http://www.cargobull.at)

## Schmitz Cargobull Sales Switzerland:

### Schmitz Cargobull Schweiz AG

Höchmatt 7  
CH-4616 Kappel SO, Switzerland  
Phone: +41 (62) 959 50 50  
Fax: +41 (62) 959 50 60  
E-mail: [info@cargobull-schweiz.ch](mailto:info@cargobull-schweiz.ch)  
Web: [www.cargobull.ch](http://www.cargobull.ch)

# SCHMITZ CARGOBULL



The Trailer Company.



Find out more at:  
[www.cargobull.com](http://www.cargobull.com)



Schmitz Cargobull AG · Bahnhofstraße 22 · D-48612 Horstmar, Germany · Phone +49 2558 81-0 · Fax +49 2558 81-500 · [www.cargobull.com](http://www.cargobull.com)